

SONY®

4-685-033-12(1)



* 4 6 8 5 0 3 3 1 2 * (1)

Television

Operating Instructions

Parts and Controls

Connecting TV to the Internet

Watching TV

Navigating through Home Menu

Viewing Pictures from Connected
Equipment

Additional Information

BRAVIA

KDL-49W750E / 49W660E / 43W750E / 40W660E / 32W660E / 32W610E

Table of Contents

Safety Information	3
Precautions	5

Parts and Controls

TV	7
Remote Control	8

Connecting TV to the Internet

Setting up the Internet Connection	10
Type 1: Secured network with Wi-Fi Protected Setup™ (WPS)	10
Type 2: Secured network without Wi-Fi Protected Setup™ (WPS)	11
Type 3: Unsecured network with any type of wireless LAN router	11
Type 4: Wired network set-up	11
Preparing a Wired Network	12
Viewing the Network Status	12

If You Cannot Connect to the Internet	12
Privacy Policy	12

Watching TV

Changing the Viewing Style	13
Changing the Wide Mode	13
Setting Scene Select	13

Navigating through Home Menu

All Apps	14
Photo Sharing Plus	14
Using the TV as a Photo Frame Mode	15
Listening to FM Radio	15
Programme List	16
Digital EPG	16
Recordings	16
Media	16
Playback Photo/Music/Video via USB	16
Playback Photo/Music/Video via Home Network	18
Settings	18
System Settings	18
Customer Support	28

Viewing Pictures from Connected Equipment

Connection Diagram	29
Using Audio and Video Equipment	31
Using Screen mirroring	31

Additional Information

Installing the TV to the Wall	32
Troubleshooting	36
Picture	36
Sound	36
Channels	37
Network	37
General	38
Specifications	39

Introduction

Thank you for choosing this Sony product.
Before operating the TV, please read this manual thoroughly and retain it for future reference.

Note

- Before operating the TV, please read the "Safety Information" (page 3).
- Instructions about "Installing the TV to the Wall" are included within this TV's instructions manual.
- Images and illustrations used in the Setup Guide and this manual are for reference only and may differ from the actual product.

Location of the Setup Guide

Setup Guide is placed on top of the cushion inside the TV carton.

Location of the identification label

Labels for the TV Model No. and Power Supply rating are located on the rear of the TV.

For models with supplied AC adapter:

Labels for the AC adapter Model No. and Serial No. are located on the bottom of the AC adapter.

Notice for customers in Thailand

This telecommunication equipment conforms to NTC technical requirement.

Notes for Australia and New Zealand model

This product is ENERGY RATING qualified in the [Home] mode. ENERGY RATING is a programme designed to promote energy efficient products and practices.

- When the TV is initially set up, it is designed to meet ENERGY RATING requirements while maintaining optimum picture quality.
- Changes to certain features, settings and functionalities of this TV (e.g. TV Guide, Picture/Sound, Eco setting) can slightly change the power consumption.

Depending upon such changed settings (e.g. [Shop] mode), the power consumption may vary which possibly could exceed the stated energy rating.

To reset the TV to ENERGY RATING qualified settings, select [Home] mode from the initial set-up procedure in [Factory Settings] under the [Customer Support] menu.

Safety Information

WARNING

Batteries must not be exposed to excessive heat such as sunshine, fire or the like.

Never place a television set in an unstable location. A television set may fall, causing serious personal injury or death. Many injuries, particularly to children, can be avoided by taking simple precautions such as:

- Using cabinets or stands recommended by the manufacturer of the television set.
- Only using furniture that can safely support the television set.
- Ensuring the television set is not overhanging the edge of the supporting furniture.
- Not placing the television set on tall furniture (for example, cupboards or bookcases) without anchoring both the furniture and the television set to a suitable support.
- Not placing the television set on cloth or other materials that may be located between the television set and supporting furniture.
- Educating children about the dangers of climbing on furniture to reach the television set or its controls.

If your existing television set is being retained and relocated, the same considerations as above should be applied.

Installation/Set-up

Install and use the TV set in accordance with the instructions below in order to avoid any risk of fire, electric shock or damage and/or injuries.

Installation

- The TV set should be installed near an easily accessible AC power outlet (mains socket).
- Place the TV set on a stable, level surface to prevent it from falling over and causing personal injury or property damage.
- Install the TV so that the TV's Table-Top Stand does not protrudes out from the TV stand (not supplied). If the Table-Top Stand protrudes out from the TV stand, it may cause TV set to topple over, fall down, and cause personal injury or damage to the TV.

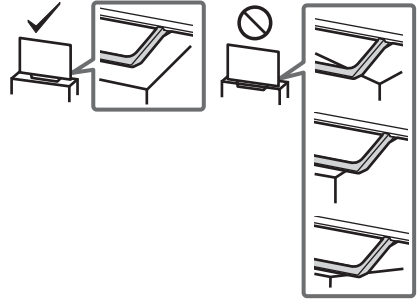

- Only qualified service personnel should carry out wall-mount installations.
- For safety reasons, it is strongly recommended that you use Sony accessories, including:
Wall-Mount Bracket: SU-WL450
- Be sure to use the screws supplied with the Wall-Mount Bracket when attaching the Wall-Mount Bracket to the TV set. The supplied screws are designed as indicated by illustration when measured from the attaching surface of the Wall-Mount Bracket. The diameter and length of the screws differ depending on the Wall-Mount Bracket model.
Use of screws other than those supplied may result in internal damage to the TV set or cause it to fall, etc.

8 mm - 12 mm

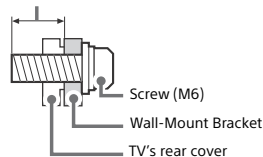

Transporting

- Before transporting the TV set, disconnect all cables.
- Two or three people are needed to transport a large TV set.
- When transporting the TV set by hand, hold it as shown below. Do not put stress on the LCD panel and the frame around the screen.
- When lifting or moving the TV set, hold it firmly from the bottom.

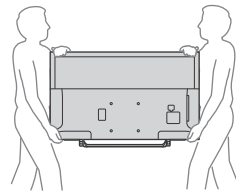

- When transporting the TV set, do not subject it to jolts or excessive vibration.
- When transporting the TV set for repairs or when moving, pack it using the original carton and packing material.

Topple prevention

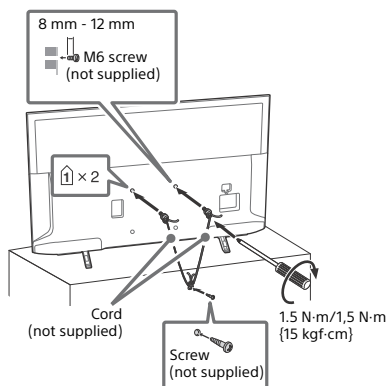

Ventilation

- Never cover the ventilation holes or insert anything in the cabinet.
- Leave space around the TV set as shown below.
- It is strongly recommended that you use a Sony Wall-Mount Bracket in order to provide adequate air circulation.

Installed on the wall

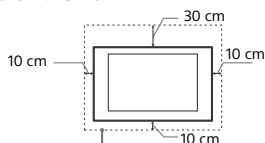

Leave at least this space around the set.

Installed with stand

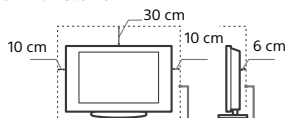

Leave at least this space around the set.

- To ensure proper ventilation and prevent the collection of dirt or dust:
 - Do not lay the TV set flat, install upside down, backwards, or sideways.
 - Do not place the TV set on a shelf, rug, bed or in a closet.
 - Do not cover the TV set with a cloth, such as curtains, or items such as newspapers, etc.
 - Do not install the TV set as shown below.

Air circulation is blocked.

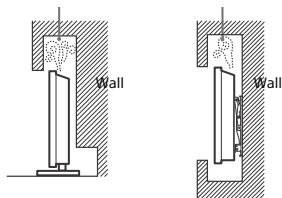

AC power cord (mains lead)

Handle the AC power cord (mains lead) and outlet (mains socket) as follows in order to avoid any risk of fire, electric shock or damage and/or injuries:

- The shape of AC power plug (mains plug), which is supplied with the TV set, varies depending on the regions. Be sure to connect the appropriate supplied AC power cord (mains lead) with the plug that fits into the AC power outlet (mains socket).
- Use only Sony supplied AC power cords (mains lead), not those of other brands.
- Insert the plug fully into the AC power outlet (mains socket).
- Operate the TV set on a 100 V - 240 V AC supply only.
- When wiring cables, be sure to unplug the AC power cord (mains lead) for your safety and take care not to catch your feet on the cables.
- Disconnect the AC power cord (mains lead) from the AC power outlet (mains socket) before working on or moving the TV set.
- Keep the AC power cord (mains lead) away from heat sources.
- Unplug the AC power plug (mains plug) and clean it regularly. If the plug is covered with dust and it picks up moisture, its insulation may deteriorate, which could result in a fire.

Note

- Do not use the supplied AC power cord (mains lead) on any other equipment.
- Do not pinch, bend, or twist the AC power cord (mains lead) excessively. The core conductors may be exposed or broken.
- Do not modify the AC power cord (mains lead).
- Do not put anything heavy on the AC power cord (mains lead).
- Do not pull on the AC power cord (mains lead) itself when disconnecting the AC power cord (mains lead).
- Do not connect too many appliances to the same AC power outlet (mains socket).
- Do not use a poor fitting AC power outlet (mains socket).

NOTE ON AC ADAPTER (models with supplied AC adapter only)

Warning

To reduce the risk of fire or electric shock, do not expose this apparatus to rain or moisture.

To prevent fire or shock hazard, do not place objects filled with liquids, such as vases, on the apparatus.

Do not install this equipment in a confined space, such as a bookshelf or similar unit.

- Please ensure that the AC power outlet (mains socket) is installed near the equipment and shall be easily accessible.
- Be sure to use the supplied AC adapter and AC power cord (mains lead). Otherwise it may cause a malfunction.
- Connect the AC adapter to an easily accessible AC power outlet (mains socket).
- Do not coil the AC power cord (mains lead) around the AC adapter. The core wire may be cut and/or it may cause a malfunction of the TV.



- Do not touch the AC adapter with wet hands.
- If you notice an abnormality in the AC adapter, disconnect it from the AC power outlet (mains socket) immediately.
- The set is not disconnected from the AC source as long as it is connected to the AC power outlet (mains socket), even if the set itself has been turned off.
- As the AC adapter will become warm when it is used for a long time, you may feel hot when touching it by hand.

Prohibited Usage

Do not install/use the TV set in locations, environments or situations such as those listed below, or the TV set may malfunction and cause a fire, electric shock, damage and/or injuries.

Locations:

- Outdoors (in direct sunlight), at the seashore, on a ship or other vessel, inside a vehicle, in medical institutions, unstable locations, near water, rain, moisture or smoke.

Environments:

- Places that are hot, humid, or excessively dusty; where insects may enter; where it might be exposed to mechanical vibration, near flammable objects (candles, etc.). The TV set shall not be exposed to dripping or splashing and no objects filled with liquids, such as vases, shall be placed on the TV.

Situations:

- Use when your hands are wet, with the cabinet removed, or with attachments not recommended by the manufacturer. Disconnect the TV set from AC power outlet (mains socket) and antenna (aerial) during lightning storms.
- Install the TV so that it sticks out into an open space. Injury or damage from a person or object bumping into the TV may result.



- Place the TV in a humid or dusty space, or in a room with oily smoke or steam (near cooking tables or humidifiers). Fire, electric shock, or warping may result.



- Install the TV in places subject to extreme temperature such as in direct sunlight, near a radiator or a heating vent. The TV may overheat in such condition which can cause deformation of the enclosure and/or TV malfunction.



- If the TV is placed in the changing room of a public bath or hot spring, the TV may be damaged by airborne sulphur, etc.



- For best picture quality, do not expose the screen to direct illumination or sunlight.
- Avoid moving the TV from a cold area to a warm area. Sudden room temperature changes may cause moisture condensation. This may cause the TV to show poor picture and/or poor colour. Should this occur, allow moisture to evaporate completely before powering the TV on.

Broken pieces:

- Do not throw anything at the TV set. The screen glass may break by the impact and cause serious injury.
- If the surface of the TV set cracks, do not touch it until you have unplugged the AC power cord (mains lead). Otherwise this may cause an electric shock.

When not in use

- If you will not be using the TV set for several days, the TV set should be disconnected from the AC power (mains) for environmental and safety reasons.
- As the TV set is not disconnected from the AC power (mains) when the TV set is just turned off, pull the plug from the AC power outlet (mains socket) to disconnect the TV set completely.
- Some TV sets may have features that require the TV set to be left in standby to work correctly.

For children

- Do not allow children to climb on the TV set.
- Warning: Keep small accessories out of the reach of children, so that they are not mistakenly swallowed (e.g., digital audio connector adapter (availability depends on countries/regions/TV models), screw, etc.).

If the following problems occur...

Turn off the TV set and unplug the AC power cord (mains lead) immediately if any of the following problems occur. Ask your dealer or Sony service centre to have it checked by qualified service personnel.

When:

- AC power cord (mains lead) is damaged.
- Poor fitting of AC power outlet (mains socket).
- TV set is damaged by being dropped, hit or having something thrown at it.
- Any liquid or solid object falls through openings in the cabinet.

About LCD TV Temperature

When the LCD TV is used for an extended period, the panel surrounds become warm. You may feel hot when touching there by the hand.

Precautions

Viewing the TV

- View the TV in moderate light, as viewing the TV in poor light or during long period of time, strains your eyes.
- When using headphones, adjust the volume so as to avoid excessive levels, as hearing damage may result.

LCD Screen

- Although the LCD screen is made with high-precision technology and 99.99 % or more of the pixels are effective, black dots may appear or bright points of light (red, blue, or green) may appear constantly on the LCD screen. This is a structural property of the LCD screen and is not a malfunction.
- Do not push or scratch the front filter, or place objects on top of this TV set. The image may be uneven or the LCD screen may be damaged.
- If this TV set is used in a cold place, a smear may occur in the picture or the picture may become dark. This does not indicate a failure. These phenomena disappear as the temperature rises.
- Ghosting may occur when still pictures are displayed continuously. It may disappear after a few moments.
- The screen and cabinet get warm when this TV set is in use. This is not a malfunction.
- The LCD screen contains a small amount of liquid crystal. Follow your local ordinances and regulations for disposal.

Handling and cleaning the screen surface/cabinet of the TV set

Be sure to unplug the AC power cord (mains lead) connected to the TV set from AC power outlet (mains socket) before cleaning. To avoid material degradation or screen coating degradation, observe the following precautions.

- To remove dust from the screen surface/cabinet, wipe gently with a soft cloth. If dust is persistent, wipe with a soft cloth slightly moistened with a diluted mild detergent solution.
- Never spray water or detergent directly on the TV set. It may drip to the bottom of the screen or exterior parts and enter the TV set, and may cause damage to the TV set.



- Never use any type of abrasive pad, alkaline/acid cleaner, scouring powder, or volatile solvent, such as alcohol, benzene, thinner or insecticide. Using such materials or maintaining prolonged contact with rubber or vinyl materials may result in damage to the screen surface and cabinet material.
- Periodic vacuuming of the ventilation openings is recommended to ensure proper ventilation.
- When adjusting the angle of the TV set, move it slowly so as to prevent the TV set from moving or slipping off from its table stand.

Optional Equipment

Keep optional components or any equipment emitting electromagnetic radiation away from the TV set. Otherwise picture distortion and/or noisy sound may occur.

Wireless Function of the unit

- Do not operate this unit near medical equipment (pacemaker, etc.), as malfunction of the medical equipment may result.
- Although this unit transmits/receives scrambled signals, be careful of unauthorised interception. We cannot be responsible for any trouble as a result.

Caution about handling the remote control

- Observe the correct polarity when inserting batteries.
- Do not use different types of batteries together or mix old and new batteries.
- Dispose of batteries in an environmentally friendly way. Certain regions may regulate the disposal of batteries. Please consult your local authority.
- Handle the remote control with care. Do not drop or step on it, or spill liquid of any kind onto it.
- Do not place the remote control in a location near a heat source, a place subject to direct sunlight, or a damp room.

Disposal of the TV set



Disposal of Old Electrical & Electronic Equipment (Applicable in the European Union and other European countries with separate collection systems)



Notice for customer in UAE

(Except KDL-49W750E / 43W750E)

TRA

REGISTERED No: ER48327/16

DEALER No: DA0105422/13

TV

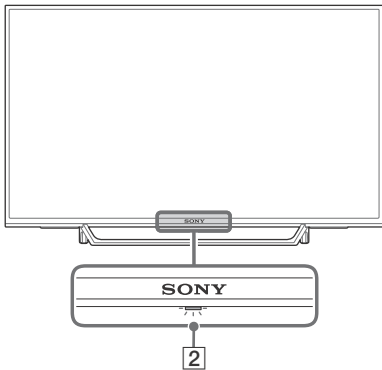
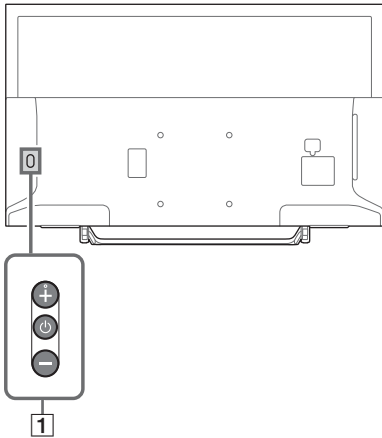

1 (Power) / + / -

Short press to turn the TV on.
Long press until the TV turn off.

When the TV is on,

Volume

Press + or - button to increase/decrease the volume.

You can also press until notification is displayed. Increases/decreases the volume by pressing the + or - button.

Input

Press until notification is displayed. Moves the selected input source by pressing + (up) or - (down) button.

Programme

Press until **PROG** notification is displayed. Select the programme by pressing + (up) or - (down) button.

2 (Sensors/LED indicator)

- Receives signals from the remote control. Do not put anything over the sensor. Doing so may affect its function.
- Lights up in amber when the [Sleep Timer] or [On Timer] is set (page 25), or the TV is in Photo Frame Mode (page 15).
- Lights up in white when [Power Saving] is set to [Picture Off] (page 27).
- Lights up in white when the TV is turned on.
- Does not light up when the TV is in standby mode.
- Flashes while the remote control is being operated.
- Lights up in red in recording mode.

Note

- Make sure that the TV is completely turned off before unplugging the AC power cord (mains lead).
- To disconnect the TV from the AC power completely, pull the plug from the mains socket.
- Please wait for a while when perform input selection to change to other input.

Remote Control

The remote control shape, location, availability and function of your remote control button may vary depending on your region/country/TV model.

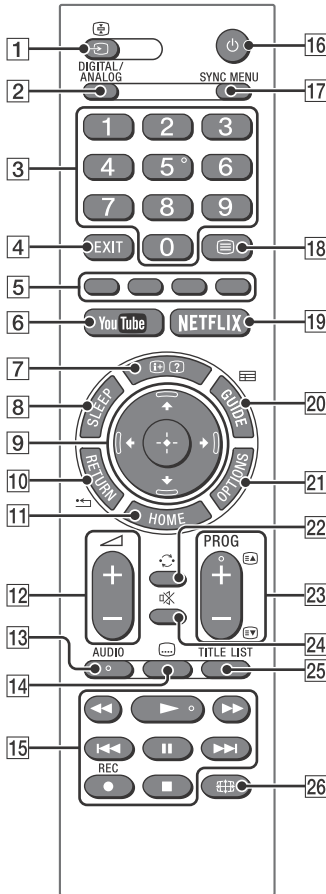

1 (Input select / Text hold)

- Displays and selects the input source.
- In text mode, holds the current page.

2 **DIGITAL/ANALOG**

Switches to digital or analogue input.

3 **Number buttons**

- Select channels. For channel numbers 10 and above, enter the next digit quickly.
- In text mode, enter the three digit page number to select the page.

4 **EXIT**

Return to the previous screen or exit from the menu. When an Interactive Application service is available, press to exit from the service.

5 **Colour buttons**

Displays operation guide (when colour buttons are available).

6 **YouTube (Only on limited region/country/TV model)**

Accesses the “YouTube” online service.

7 (Info / Text reveal)

- Displays information. Press once to display information about the programme/input you are viewing. Press again to remove the display from the screen.
- In text mode, reveals hidden information (e.g. answers to a quiz).

8 **SLEEP**

Press repeatedly until the TV displays the time in minutes ([Off]/[15 min]/[30 min]/[45 min]/[60 min]/[90 min]/[120 min]) that you want the TV to remain on before shutting off. To cancel the sleep timer, press **SLEEP** repeatedly until [Off] appears.

9 (Item select / Enter)

- Select or adjust items.
- Confirm selected items.

10 **RETURN**

- Returns to the previous screen of any displayed menu.
- Stops playback when playing photo/music/video file.

11 **HOME**

Displays or cancels the menu.

12  +/- (Volume)

Adjust the volume.

13 **AUDIO**

Select the sound of multilingual source or dual sound for the programme currently being viewed (Depend on programme source).

14  (Subtitle)

Changes the subtitle setting (page 21).

15 

- Operate media contents on TV and connected BRAVIA Sync-compatible device.
- This key also can be used to operate VOD (Video on Demand) service playback. Availability is depend on VOD service.

● REC (Australia and New Zealand model only)

Record the current programme with the USB HDD recording function.

←•/•→ (Except Australia and New Zealand model)

Replays the scene/briefly fast forwards the scene.

16  (TV standby)

Turns the TV on or switches to standby mode.

17 **SYNC MENU**

Press to display the BRAVIA Sync Menu and then select connected HDMI equipment from [Device Selection].

The following options can be selected from BRAVIA Sync Menu.

Device Control:

Use the [Device Control] to operate equipment that is compatible with BRAVIA Sync Control. Select options from [Home (Menu)], [Options], [Content List] and [Power Off] to operate the equipment.

Speakers:

Select [TV Speakers] or [Audio System] to output the TV's sound from the TV speakers or connected audio equipment.

TV Control:

Use the [TV Control] menu to operate the TV from the [Home (Menu)] or [Options] menu.

Return to TV:

Select this option to return to TV programme.

18  (Text)

In text mode, displays Text broadcast.

Each time you press , the display changes cyclically as follows:

Text → Text over the TV picture (mix mode) → No Text (exit the Text service)

19 **NETFLIX (Only on limited region/country/TV model)**

Accesses the "NETFLIX" online service.

20  **GUIDE (EPG)**

Displays the Digital EPG (Electronic Programme Guide) (page 16).

21 **OPTIONS**



Displays a list that contains shortcuts to some setting menus.

The listed options vary depending on the current input and content.

22  (Jump)

Returns to the previous channel or input viewed more than 15 seconds.

23 **PROG +/-/⏪/⏩**

- Selects the next (+) or previous (-) channel.
- In text mode, selects the next () or previous () page.

24  (Mute)

Mutes the sound. Press again to restore the sound.

25 **TITLE LIST (Australia and New Zealand model only)**

Display the Title list.

26  (Wide Mode)

Adjusts the screen display. Press repeatedly to select the desired wide mode (page 13).

Hint

- The number **5**, , **PROG +** and **AUDIO** buttons have tactile dots. Use the tactile dots as references when operating the TV.

Connecting TV to the Internet

Setting up the Internet Connection

To use the network features of your TV it needs to be connected to the Internet. The set-up procedure differs depending on the type of network and LAN router. Before setting up the Internet connection, be sure to set up a LAN router. Check your wireless LAN environment using the following chart.

Wireless LAN

Secure Wireless LAN?	NO ⇒ Type 3
YES ↓	
Do you use a wireless LAN router compatible with Wi-Fi Protected Setup™ (WPS)?	NO ⇒ Type 2
YES ↓	
Type 1*	

Wired LAN → Type 4

* Type 1 is easier to set up if your router has an automatic setting button, e.g. Air Station One-Touch Secure System (AOSS). Most of the latest routers have this function. Check your router.

Type 1: Follow the configuration for **Secured network with Wi-Fi Protected Setup™ (WPS)**.

Type 2: Follow the configuration for **Secured network without Wi-Fi Protected Setup™ (WPS)**.

Type 3: Follow the configuration for **Unsecured network with any type of wireless LAN router**.

Type 4: Follow the configuration for **Wired network set-up**.

Type 1: Secured network with Wi-Fi Protected Setup™ (WPS)

The WPS standard makes security of a wireless home network as straightforward as pressing the WPS button on the wireless LAN router. Before setting up a wireless LAN, check the location of the WPS button on the router and verify how to use it.

For security purpose, [WPS (PIN)] provides a PIN code for your router. PIN code is renewed every time you select [WPS (PIN)].

1 Press **HOME**, then select [Settings] → [System Settings] → [Set-up] → [Network] → [Network Set-up].

2 IP Address setting/Proxy server:

– automatic setting:

[Set up network connection] → [Easy]

– manual setting:

[Set up network connection] → [Expert] → [Wired Set-up] or [Wireless Set-up]

3 Select [WPS (Push Button)] for Push Button method or [WPS (PIN)] for PIN method.

Note

Button name of the WPS may differ depending on the router (e.g. AOSS button).

4 Follow the instructions on the set-up screen.

Note

- If you use WPS for network set-up, the security settings of the wireless LAN router activate, and any equipment previously connected to the wireless LAN in a non-secure status will be disconnected from the network. In this case, activate the security settings of the disconnected equipment and then reconnect. Or, you can deactivate the security settings of the wireless LAN router, and then connect the equipment to a TV in a non-secure status.
- To use the network with IPv6, select [Settings] → [System Settings] → [Set-up] → [Network] → [IPv6/IPv4 Priority] → [IPv6], then select [Easy] in [Set up network connection].
- When IPv6 is selected, HTTP Proxy cannot be set.

Type 2: Secured network without Wi-Fi Protected Setup™ (WPS)

To set up a wireless LAN, SSID (wireless network name) and security key (WEP or WPA key) will be required. If you do not know them, consult the instruction manual of your router.

- 1 Press **HOME**, then select [Settings] → [System Settings] → [Set-up] → [Network] → [Network Set-up].
- 2 IP Address setting/Proxy server:
 - automatic setting:
[Set up network connection] → [Easy]
 - manual setting:
[Set up network connection] → [Expert] → [Wired Set-up] or [Wireless Set-up]
- 3 Select [Scan], then select a network from the list of scanned wireless networks.
- 4 Follow the instructions on the set-up screen.

Note

- To use the network with IPv6, select [Settings] → [System Settings] → [Set-up] → [Network] → [IPv6/IPv4 Priority] → [IPv6], then select [Easy] in [Set up network connection].
- When IPv6 is selected, HTTP Proxy cannot be set.
- Please make sure your surrounding is secure when you key in your password.

Type 3: Unsecured network with any type of wireless LAN router

To set up a wireless LAN, SSID (wireless network name) will be required.

- 1 Press **HOME**, then select [Settings] → [System Settings] → [Set-up] → [Network] → [Network Set-up].
- 2 IP Address setting/Proxy server:
 - automatic setting:
[Set up network connection] → [Easy]
 - manual setting:
[Set up network connection] → [Expert] → [Wired Set-up] or [Wireless Set-up]
- 3 Select [Scan], then select a network from the list of scanned wireless networks.
- 4 Follow the instructions on the set-up screen.

Note

- Security key (WEP or WPA key) will not be required because you do not need to select any security method in this procedure.
- To use the network with IPv6, select [Settings] → [System Settings] → [Set-up] → [Network] → [IPv6/IPv4 Priority] → [IPv6], then select [Easy] in [Set up network connection].
- When IPv6 is selected, HTTP Proxy cannot be set.

Type 4: Wired network set-up

Enter the respective alphanumeric values for your router if necessary. The items that need to be set (e.g. IP Address, Subnet Mask, DHCP) may differ depending on the Internet service provider or router. For details, refer to the instruction manuals provided by your Internet service provider, or those supplied with the router.

- 1 Press **HOME**, then select [Settings] → [System Settings] → [Set-up] → [Network] → [Network Set-up].
- 2 IP Address setting/Proxy server:
 - automatic setting:
[Set up network connection] → [Easy]
 - manual setting:
[Set up network connection] → [Expert] → [Wired Set-up] or [Wireless Set-up]

3 Follow the instructions on the set-up screen.

[Network Set-up] can also be set from [Auto Start-up] menu.

Note

- Allows automatic configuration of your wired/wireless network.
 - When connecting with LAN cable: Wired
 - When connecting with built-in Wireless LAN: Wireless
 - When connecting with both of the cables: Wired
- Set to [Easy], sets the IP address automatically. For proxy server is not use.
- To use the network with IPv6, select [Settings] → [System Settings] → [Set-up] → [Network] → [IPv6/IPv4 Priority] → [IPv6], then select [Easy] in [Set up network connection].
- When IPv6 is selected, HTTP Proxy cannot be set.

Preparing a Wired Network

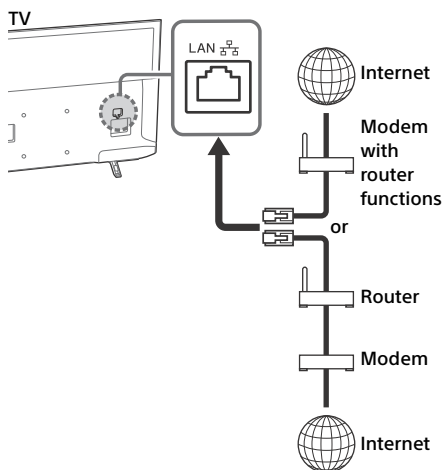

Note

- For LAN connections, use a Category 7 cable (not supplied).

Viewing the Network Status

You can confirm your network status.

- 1 Press **HOME**, then select [Settings] → [System Settings] → [Set-up] → [Network] → [Network Set-up].
- 2 Select [View Network setting and status].

If You Cannot Connect to the Internet

Use the diagnosis to check possible causes for network connection failures, and settings.

- 1 Press **HOME**, then select [Settings] → [System Settings] → [Set-up] → [Network] → [Network Set-up].

- 2 Select [View Network setting and status].

- 3 Select [Check Connection].

This may take several minutes. You cannot cancel the diagnosis after selecting [Check Connection].

Privacy Policy

When you use the following functions to connect to the Internet, certain information will be sent to Sony Corporation's global servers, which is considered to be personal information, and requires your agreement in order for service providers to use it.



- System software updates by connecting to Sony Corporation's global servers via the Internet.
- Internet contents or other Internet services from service providers like YouTube.

This TV has the setting screens in Auto Start-up or Setting Menu to confirm your agreement to this after you read the detail of the Privacy Policy. If you want to use these functions, please check [Agree] in each setting screen. If [Disagree] is checked, the above two functions are not available.

However, even in this case, if [On] is selected at [Automatic Software Download] in Auto Start-up or Setting Menu, the system software updating is available.

You can change this setting by pressing **HOME**, then select [Settings] → [System Settings] → [Set-up] → [Privacy Policy].

Watching TV

- 1 Press  on the TV or the remote control to turn on the TV.
- 2 Press **DIGITAL/ANALOG** to switch between digital and analogue inputs.
- 3 Press the number buttons or **PROG +/-** to select a TV channel.
- 4 Press  +/- to adjust the volume.

Changing the Viewing Style

Changing the Wide Mode

- 1 Press  repeatedly to select the wide mode.

[Wide Zoom]*

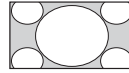

[Normal]

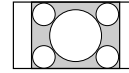

[Full]

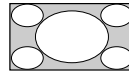

[Zoom]*

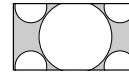

[14:9]*

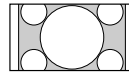

* Parts of the top and bottom of the picture may be cut off.

For HDMI PC Input (PC timing)

[Normal]

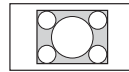

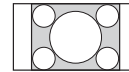

[Full 1]

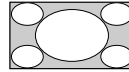

[Full 2]



Setting Scene Select

- 1 Press **OPTIONS**.
- 2 Press  then  to select [Scene Select].

When you select the desired scene option, the optimum picture and sound quality for selected scene are automatically set. The options you can select may vary. Unavailable options are greyed out.

Navigating through Home Menu

The **HOME** button allows you to access a variety of TV settings and features.

All Apps

Internet Contents delivers a variety of on-demand entertainment straight to your TV. You can enjoy your favorite internet content, Photo Sharing Plus, Photo Frame Mode and FM Radio.

Note

- Be sure to connect your TV to the Internet and complete [Network Set-up] (page 24).

To use Internet Contents

- 1 Press **HOME**, then select [All Apps].
- 2 Press $\uparrow/\downarrow/\leftarrow/\rightarrow$ to select the desired internet service in service list.
- 3 Press \odot to launch the desired internet contents.
- 4 Press the red/green/yellow/blue button to filter the app category by Photo/Music/Video/All.

To exit Internet Contents

Press **HOME**.

Note

- If you experience difficulties with this feature, check that the Internet connection is set up properly.
- The interface to Internet content depends on the Internet content providers.
- To update Internet Contents services. Press **HOME**, then select [Settings] → [System Settings] → [Set-up] → [Network] → [Refresh Internet Content].

To use NETFLIX

Press **NETFLIX** button on the remote control to launch menu.

Note

- It is possible that Netflix cannot be used via a Proxy server.

Photo Sharing Plus

Connect, view and save favourite photos on TV using your devices (eg. smartphones or tablets).

HOME → [All Apps] → [Photo Sharing Plus]

Note

- Follow the instructions on the screen to connect your device to the TV.
- Open web browser on device after all connections are established, then follow the instructions on the screen to access the URL.

To display photo on TV

- 1 Tap on your device to start.
- 2 Select a photo.
The selected photo will be displayed automatically on TV.

To save a photo displayed on TV

- 1 Tap thumbnail on your device, then hold the photo to open the context menu.
- 2 Select [OK].

Note

- Connect a USB flash drive to store up to 50 photos.
- Up to 10 smartphones or tablets can be connected to the TV at the same time.
- Maximum file size of each photo is 20 MB.
- You can also throw a background music with a maximum file size of 30 MB.
- The default browser for Android 2.3 or later is supported.
- The default browser for iOS is supported; however, some functions cannot be used depending on the version of your iOS.

Using the TV as a Photo Frame Mode

Photo Frame Mode displays the clock and calendar at the same time as displaying a photo, and listening to music or FM radio.

HOME → [All Apps] → [Photo Frame Mode]



To launch Photo Frame Mode while playback USB media

- 1 Press **OPTIONS** while playback a photo or music file.
- 2 Press \uparrow/\downarrow then \odot to select [Photo Frame Mode] to launch Photo Frame.

To select Display mode

You can change the Photo Frame Mode display by selecting [Display Mode] in the [Photo Frame Settings] (page 24).

To select Clock Display mode

You can select among three clock display modes by selecting [Clock Display] in the [Photo Frame Settings] (page 24).

Note

- This TV does not have a battery powered backup for the clock. If there is a power failure or if you disconnect the power cord, the current date and time will reset automatically.

Duration

To save power, the TV continually plays back in Photo Frame Mode for up to 24 hours before powering off automatically. After automatic power off, do not use Photo Frame Mode for at least one hour to avoid panel burn-in. You can change the setting of the [Duration] in the [Photo Frame Settings] (page 24).

To avoid panel burn-in, the position of the photo, clock and calendar are switched automatically every hour.

Listening to FM Radio

HOME → [All Apps] → [FM Radio]

Note

- Press **PROG +/-** to select an FM radio station. Press \leftarrow **RETURN** to exit FM Radio mode.

Presetting Radio Stations

When you use FM Radio function for the first time, press **HOME** and select [Settings] → [System Settings] → [Channel Set-up] → [FM Radio Set-up] → [Auto Tuning].

To change preset radio stations

- 1 Press **OPTIONS** in FM Radio mode.
- 2 Press \uparrow/\downarrow then \odot to select [FM Radio Presets].
- 3 Press \uparrow/\downarrow then \odot to select the radio station you want to change.
- 4 Press \uparrow/\downarrow then \odot to change the FM frequency then to edit FM Radio station name.

Note

- If the station has a noisy sound, you may be able to improve the sound quality by pressing \leftarrow/\rightarrow .
- When an FM stereo programme has static noise, press **AUDIO** until [Mono] appears. There will be no stereo effect, but the noise will be reduced.

Programme List

- 1 Press **HOME** in digital mode.
- 2 Press \uparrow/\downarrow then \ominus to select [Programme List].

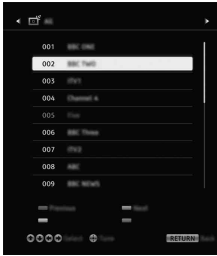

- 3 Press $\uparrow/\downarrow/\leftarrow/\rightarrow$ then \ominus to select a programme.

To use the Favourite list

The Favourite feature allows you to specify up to four lists of your favourite programmes. While watching TV, press \ominus to create or display a Favourite list.

Hint

- Press the blue button to edit the Favourite list. Follow the guides at the bottom of the screen.

Digital EPG

- 1 Press \equiv **GUIDE** in digital mode.

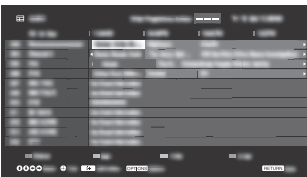

- 2 Press $\uparrow/\downarrow/\leftarrow/\rightarrow$ then \ominus to select a programme.

Recordings

(Australia and New Zealand model only)

- 1 Press **HOME** in digital mode.
- 2 Press \uparrow/\downarrow then \ominus to select [Recordings].
- 3 Press \uparrow/\downarrow then \ominus to select [Title List], [Timer List], [Error List] or [Manual timer REC].

Note

- Press **REC** button to record currently viewed programme in digital mode with USB HDD recording function.
- Be sure to connect the HDD to the TV before recording.

Media

Playback Photo/Music/Video via USB

You can enjoy photo/music/video files stored in a Sony digital still camera/camcorder/smartphone (depending on models)* through a USB cable or USB storage device on your TV.

- 1 Connect a supported USB device to the TV.

* Device needs to be in Media transfer mode (MTP).

- 2 Press **HOME**.
- 3 Press \uparrow/\downarrow then \ominus to select [Media].
- 4 Press \uparrow/\downarrow then \ominus to select [Photo], [Music] or [Video].
- 5 [Device Selection] appears. Press \uparrow/\downarrow then \ominus to select a device.
- 6 Press $\uparrow/\downarrow/\leftarrow/\rightarrow$ then \ominus to select a file or folder.

Playback Options

Press the red button in thumbnail view to display the list of USB playback settings.

Display Settings

Press **OPTIONS** in thumbnail view to display the option to change the thumbnail view to list view.

To adjust the picture and sound quality of USB media

Press **OPTIONS** during media playback then select [Picture] or [Sound].

Note

- Press $\uparrow/\downarrow/\leftarrow/\rightarrow$ then \odot to select and adjust an item.

To play a photo as a slideshow (Photo)

1 Press the green button in thumbnail/list view to start slideshow.

To set [Slideshow Effect] and [Slideshow Speed], press **OPTIONS** → [Playback Options].

To stop a slideshow, press \leftarrow **RETURN**.

Note

- While the TV is accessing the data on a USB device, observe the following:
 - Do not turn off the TV.
 - Do not disconnect the USB cable.
 - Do not remove the USB device.The data on the USB device may be damaged.
- Sony will not be held liable for any damage to, or loss of, data on the recording media due to a malfunction of any connected devices or the TV.
- The file system on the USB device supports FAT16, FAT32 and NTFS.
- The file name and folder name may not display correctly in some cases.
- When you connect a Sony digital still camera, set the camera's USB connection mode to Auto or Mass Storage. For more information about USB connection mode, refer to the instructions supplied with your digital camera.
- Use a USB storage device that is compliant with USB mass storage device class standards.
- If a selected file has incorrect container information, or is incomplete, it cannot be played back.

USB Video format

- AVI (.avi)**
Video Codec: MPEG1, MPEG2, Xvid, MPEG4, H.264, Motion JPEG
Audio Codec: PCM, MPEG1 Layer1/2, MPEG2 AAC (2ch), MPEG4 AAC (2ch), MPEG4 HE-AAC (2ch), Dolby Digital (2ch), Dolby Digital Plus (2ch), WMA v8, MP3
- ASF (.wmv, .asf)**
Video Codec: WMV v9, Xvid, VC-1
Audio Codec: MP3, WMA v8
- MP4 (.mp4, .mov, .3gp)**
Video Codec: MPEG4, H.264, H.263, Motion JPEG, H.265
Audio Codec: MPEG1 Layer1/2, MP3, MPEG2 AAC, MPEG4 AAC, MPEG4 HE-AAC

- MKV (.mkv)**
Video Codec: WMV v9, MPEG4, H.264, VC-1, VP8, VP9, H.265
Audio Codec: PCM, MPEG1 Layer1/2, MP3, MPEG2 AAC (2ch), MPEG4 AAC (2ch), Dolby Digital (2ch), WMA v8, Dolby Digital Plus (2ch), DTS, FLAC, VORBIS
- WebM (.webm)**
Video Codec: VP8, VP9
Audio Codec: VORBIS
- PS (.mpg, .mpeg, .vro, .vob)**
Video Codec: MPEG1, MPEG2
Audio Codec: MPEG1 Layer1/2, MP3, Dolby Digital (2ch), Dolby Digital Plus (2ch), DTS, DTS 2.0
- TS (.ts, .m2ts)**
Video Codec: MPEG2, H.264, VC-1, H.265
Audio Codec: MPEG1 Layer1/2, MP3, MPEG2 AAC, MPEG4 AAC, MPEG4 HE-AAC, Dolby Digital (2ch), Dolby Digital Plus (2ch), DTS, DTS 2.0

USB Music format

- LPCM, DTS-CD (.wav)
- MPEG1 audio layer3 (.mp3)
- WMA V8 (.wma)
- FLAC (.flac)

USB Photo format

- JPEG (.jpg, .jpeg)

Note

- Playback of the above file formats is not guaranteed.

Playback Photo/Music/Video via Home Network

You can enjoy various content (e.g. photo/music/video files) stored on DLNA Certified™ media servers. The home network feature allows you to enjoy network content in other rooms.

Playing Photo/Music/Video

- 1 Press **HOME**, then select [Media] → [Photo], [Music] or [Video] → the desired media server.
- 2 Select files or folders to play from the list.

Note

- The server is required to be DLNA Certified™.
- Files from a network device need to be in the following formats:
 - Still images: JPEG
 - Music: MP3, linear PCM, WMA
 - Video: AVCHD, MPEG2, MPEG1, MP4 (AVC), MP4 (MPEG4), WMV
- Depending on the file, playback may not be possible even when using the supported formats.

Renderer

You can play back photo, music and video files stored in network devices (e.g. digital still cameras, mobile phones, PC) on the TV screen by directly operating the target device. The network should also be renderer-compatible devices.

Renderer settings

Press **HOME**, then select [Settings] → [System Settings] → [Set-up] → [Network] → [Home Network Setup] → [Renderer].

Display Settings for Media Servers

Select home network servers to be displayed in the Home Menu. Up to 10 servers can be displayed.

- 1 Press **HOME**, then select [Settings] → [System Settings] → [Set-up] → [Network] → [Home Network Setup] → [Server Display Settings].
- 2 Select the server to display in the Device Selection.

Settings

System Settings

Note

- The options you can adjust vary depending on the situation. Unavailable options are greyed out or not displayed.

Picture

Picture Mode

Sets a picture mode.

Reset

Resets all the [Picture] settings except [Picture Mode] and [Intelligent Picture Plus] to the default settings.

Backlight

Adjusts the brightness of the backlight.

Picture

Increases or decreases picture contrast.

Brightness

Brightens or darkens the picture.

Colour

Increases or decreases colour intensity.

Hue

Increases or decreases the green tones and red tones.

Colour Temperature

Adjusts the whiteness of the picture.

Sharpness

Sharpens or softens the picture.

Reality Creation

Adjusts fineness and noise for realistic picture.

Resolution: Adjusts fineness and clarity. Select [Manual] from [Reality Creation] to adjust the [Resolution].

Noise Reduction

Reduces the picture noise (snowy picture) in a weak signal.

MPEG Noise Reduction

Reduces the picture noise in MPEG-compressed video.

Film mode

Provides improved picture movement when playing BD (Blu-ray Disc), DVD or VCR images taken on film. Select [Auto] to represent original film-based content as it is.

Note

- If the image contains irregular signals or too much noise, [Film mode] is automatically turned off even if [Auto] is selected.
-

Advanced Settings

Sets [Picture] settings in more detail.

Reset: Resets all the advanced settings to the default settings.

Adv. Contrast Enhancer: Automatically adjusts [Backlight] and [Picture] to the most suitable settings for dark images scenes.

Black Corrector: Enhances black areas of the picture for stronger contrast.

Gamma: Adjusts the balance between bright and dark areas of the picture.

Clear White: Emphasises white colours.

Live Colour: Makes colours more vivid.

LED Motion Mode: Reduces blur in movies by controlling the LED backlight source, but the brightness decreases.

Colour Space (KDL-49W750E / 43W750E only): Changes colour reproduction range.

Intelligent Picture Plus Set-up

Intelligent Picture Plus: Enhances picture quality according to preferred settings, channel or video input.

Signal Level Indicator: When [On] is selected, the signal level bar will be displayed when you select analogue channel or video input.

Picture Optimisation: Allows you to enhance the picture to your preferred settings.

Sound

ClearAudio+

Let you enjoy the best sound quality by the combination of a well-balanced digital signal processing technology.

Sound Mode

Select according to content you want to enjoy.

Reset

Reset [Surround], [Surround effect], [Sound restoration (DSEE)], [Equaliser], [Voice Zoom], [Advanced auto volume], [Balance], and [Volume Offset] settings.

Surround

Virtually reproduce realistic surround sound.

Surround effect

Adjust the surround sound effect.

Sound restoration (DSEE)

Reproduce the spatial natural sound quality by decoding high frequencies and small sound often lost by digital compression.

Equaliser

Adjusts sound frequency settings.

Voice Zoom

Emphasize voice or ambient audio.

Advanced auto volume

Automatically compensates for the volume level that may vary by programme or input.

Balance

Emphasises left or right speaker balance.

Volume Offset

Adjusts the volume level of the current input relative to other inputs.

Dual Sound

Sets the sound from the speaker to [Mono], [Stereo], [Main] or [Sub].

Note

- If the signal is very weak, the sound becomes monaural automatically.
- If the stereo sound is noisy when receiving a NICAM programme, select [Mono]. The sound becomes monaural, but the noise is reduced.
- The [Dual Sound] setting is memorized for each programme position.
- You cannot listen to stereo broadcast sound when [Mono] is selected.

Hint

- If you select other equipment connected to the TV, set [Dual Sound] to [Stereo], [Main] or [Sub].

Advanced Settings

Dynamic Range: Compensates for differences in the audio level between different channels.

Note

- The effect may not function or may vary depending on the programme regardless of the [Dynamic Range] setting.

Dolby Digital Plus Out: Select [Auto] to pass through Dolby Digital Plus stream to ARC when Dolby Digital Plus is available through connected Audio System.

During Dolby Digital Plus stream is output, Digital Audio Out (optical)* is muted.

Select [Off] to convert Dolby Digital Plus stream to Dolby Digital for both ARC (Audio system) and Digital Audio Out (optical)*.

HE-AAC Audio Level: Adjust the HE-AAC audio sound level.

MPEG Audio Level: Adjusts the MPEG audio sound level.

* Only on limited region/country/TV model.

Screen

Wide Mode

For details about wide mode, see page 13.

Auto Wide

Automatically changes the wide mode according to the input signal from an external equipment.

4:3 Default

Sets the default [Wide Mode] for a 4:3 input signal.

Auto Display Area

Select [On] to automatically adjusts the display area based upon the content or [Off] to choose from the [Display Area] options.

Display Area

Adjusts the picture display area.

Horizontal Shift

Adjusts the horizontal position of the picture.

Vertical Shift

Adjusts the vertical position of the picture.

Vertical Size

Adjusts the vertical size of the picture when [Wide Mode] is set to [Wide Zoom].

PC Settings

Select [Wide Mode], see page 13.

Channel Set-up

Analogue Set-up

Analogue Auto Tuning: Tunes in all the available analogue channels. Usually you do not need to do this operation because the channels are already tuned when the TV was first installed. However, this option allows you to repeat the process (e.g., to retune the TV after moving house, or to search for new channels that have been launched by broadcasters).

Manual Programme Preset: Before selecting [Channel]/[AFT]/[Audio Filter]/[Skip]/[Colour System], press **PROG +/-** to select the programme number with the channel. You cannot select a programme number that is set to [Skip] (page 21).

Programme/TV System

Presets programme channels manually.

Channel

Selects a channel number.

AFT

Allows you to fine-tune the selected channel manually. When [On] is selected, the fine tuning is performed automatically.

Audio Filter

Improves the sound of individual channels when distortion occurs in mono broadcasts in TV system [B/G], [I], [D/K] and [M].

Note

- You cannot receive stereo or dual sound when [Low]/[High] is selected.

Skip

Skips unused channels.

Colour System

Select the colour system according to the channel.

Signal Level

Displays the signal level for programme currently being watched.

Programme Sorting: Changes the order in which the channels are stored on the TV.

Digital Set-up

Digital Tuning:

Digital Auto Tuning

Tunes in the available digital channels. This option allows you to retune the TV after moving house, or to search for new channels that have been launched by broadcasters.

Auto Tuning Range

Normal: Searches for available channels within your region/country.

Full: Searches for available channels regardless of region/country.

Note

- You can run [Digital Auto Tuning] after moving to a new residence, changing service providers, or to search for newly launched channels.

Programme List Edit

Removes any unwanted digital channels stored on the TV, and changes the order of the digital channels stored on the TV.

Digital Manual Tuning

Tunes the digital channels manually.

Subtitle Set-up:

Subtitle Setting

When [For Hard Of Hearing] is selected, some visual aids may also be displayed with the subtitles (if TV channels broadcast such information).

Primary Preferred Language

Select preferred language which subtitles are displayed in.

Secondary Preferred Language

Select secondary preferred language which subtitles are displayed in.

Audio Set-up:

Audio type (Audio description)

Normal

Provide normal audio type.

Audio Description

Provides audio description (narration) of visual information if TV channels broadcast such information.

For Hard Of Hearing

Switches to broadcast for the hearing impaired when [For Hard Of Hearing] is selected.

Spoken subtitle

Switches to broadcast for the spoken subtitle audio if TV channels broadcast such information.

Primary Preferred Language

Select the preferred language used for a programme. Some digital channels may broadcast several audio languages for a programme.

Secondary Preferred Language

Select the secondary preferred language used for a programme. Some digital channels may broadcast several audio languages for a programme.

Mixing Level

Adjusts the TV main audio and Audio Description output levels.

Hint

- This option is only available when [Audio Description] in [Audio Type (Audio Description)] is set.

Guide set-up:

Preferred Language (Singapore model only)

Select the preferred language used for an event information display. Some digital channels may broadcast several languages for event information display.

Update Guide in standby

TV obtains EPG data during standby mode.

Technical Set-up:

Auto Service Update

Enables the TV to detect and store new digital services as they become available.

Service Replacement

Select [On] to automatically change the channel when broadcaster changes transmission of the viewing programme to a different channel.

Postal code (Indonesia model only)

Set your location to receive region specific information.

Interactive Application Setup (Only on limited region/country/TV model):

The interactive application service offers high-quality digital text and graphics, along with advanced options. The service is supported by broadcasters.

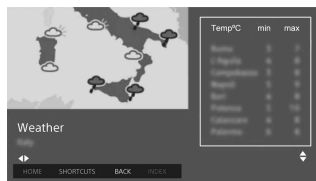

Interactive Application

Enables the viewing of programmes featuring interactive services.

Auto Start Application

Launches broadcast-related applications automatically.

Application for (Prog. [current program])

Enables the interactive application service for the current programme.

Note

- The interactive service is only available if provided by the broadcaster.
- Available functions and screen content vary depending on the broadcaster.

FM Radio Set-up

Presets up to 30 FM radio channels that can be received in your area.

Auto Tuning: Allows you to automatically tune and store all the available channels.

FM Radio Presets: Allows you to manually tune and store each available channel one at a time.

Note

- To enable this feature, access to FM Radio mode by using Home (Menu) (page 15), then preset your desired FM radio channels according to the steps mentioned above.

Parental Lock

PIN Code

Sets a PIN code. Use **0-9** on the remote control to enter a four-digit PIN code.

Change PIN Code

Select to change your PIN code.

Parental Rating

Except Australia, New Zealand, Singapore and South Africa model:

Sets an age restriction to viewing. To view any programme rated for ages above the age you specify, enter the correct PIN code.

Australia model and New Zealand model:

Sets a parental guidance level. Programmes that exceed the set level can only be watched after entering the correct PIN code.

Australia model:

Block All: All programmes need a password to view.

G and above: To lock "General" and above programmes.

PG and above: To lock "Parental Guidance" and above programmes.

M and above: To lock "Mature" and above programmes.

MA and above: To lock "Mature Adult" and above programmes.

AV and above: To lock "Adult/Violence" and above programmes.

R and above: To lock "Restricted" and above programmes.

No block: No programmes need a password to view.

New Zealand model:

Block All: All programmes need a password to view.

G and above: To lock "General" and above programmes.

PGR and above: To lock "Parental Guidance Recommended" and above programmes.

AO and above: To lock "Adults Only" and above programmes.

No block: No programmes need a password to view.

Singapore model:

G: To lock "General" and above programmes.

PG: To lock "Parental Guidance" and above programmes.

PG13: To lock "Parental Guidance 13" and above programmes.

NC16: To lock "No Children Under 16" and above programmes.

M18: To lock "Mature 18" and above programmes.

R21: To lock "Restricted 21" and above programmes.

No block: No programmes need a password to view.

South Africa model:

PG10: To lock "Parental Guidance 10" and above programmes.

10: Set parental restriction for age 10 and below.

PG13: To lock "Parental Guidance 13" and above programmes.

13: Set parental restriction for age 13 and below.

16: Set parental restriction for age 16 and below.

18: Set parental restriction for age 18 and below.

R18: To lock "Restricted 18" and above programmes.

No block: No programmes need a password to view.

Digital Programme Block

Locks a digital channel from being watched. To view a blocked channel, select [Unblocked].

External Input Lock

Locks an external input from being watched. To view a blocked external input, select [Unblocked].

Note

- Entering the correct PIN code for blocked channel or external input will temporarily deactivate the [Parental Lock] feature. To reactivate the [Parental Lock] settings, turn off and on the TV.

Hint

- If you lost your PIN code, see page 38.

Internet Lock

Locks internet contents from being watched.

To view an internet contents, select [Unblocked].

Set-up

Network

Network Set-up: Sets the network status settings.

IPv6/IPv4 Priority: Switch between [IPv6] and [IPv4 (Recommended)].

Note

- To use the network with [IPv6], select [IPv6], then select [Easy] in [Set up network connection].
- When IPv6 is selected, HTTP Proxy cannot be set.
- When IPv6 is selected, some Internet browser sites, applications or contents cannot be watched.

Built-in Wi-Fi: Turns the built-in wireless LAN [On] or [Off].

Set to [Off], if you do not use the built-in wireless LAN.

When you switch from [Off] to [On], establish the network connection via [Network Set-up].

Wi-Fi Direct: Turns on/off to connect your TV with Wi-Fi Direct device such as PC, mobile phone or digital camera.

Wi-Fi Direct Settings: Set to connect a Wi-Fi direct device to the TV using the Wi-Fi Direct function. If you cannot connect, press **OPTIONS** key and select [Manual].

Device Name: Change the name of the TV shown on the connected device.

Refresh Internet Content: Connect to the internet to receive available Internet content services.

Home Network Setup:

Server Display Settings

Displays the connected server list. You can select the server to display in the Device Selection.

Server Diagnostics

Diagnoses whether the TV can connect to each server on the home network.

Remote Start

This feature allow connected device in the home network to turn on the TV.

Note

- The standby power consumption will increase if [On] is set.

Renderer

Renderer Function

Enables the TV to play media files on a device (e.g. digital still camera).

Renderer Access Control

Allows access from a specified control device.

Renderer Set-up

Adjusts the [Renderer Set-up] detailed settings.

Privacy Policy

Select [Agree] or [Disagree] for Privacy Policy confirmation. (page 12)

Photo Frame Settings

Display Mode: Allows you to select the display mode. See page 15.

Clock Display: Allows you to select the clock display.

Note

- This option is available when [Display Mode] is set to [Image and Clock] or [Full Screen Clock].

Audio Application: Sets [FM Radio], [Music] or [Off] as audio application.

Image Selection: Select image.

Music Selection: Select music.

Slideshow Setting: Select from showing slideshow mode or single view photo.

Music Playback Setting: Select from listening to all tracks or a single music track.

Duration: Select the time period after which the TV automatically switches to standby mode.

First day of the week: Sets [Sunday] or [Monday] as the first day of the week on the calendar.

USB Auto Start

When USB device is connected to the USB port, select [On] to automatically view the thumbnail of the last played Photo/Music/Video.

Clock/Timers

Sets the timer and clock.

Sleep Timer: Sets the time in minutes that you would like the TV to remain on before shutting off automatically.

On Timer: Turns on the TV from standby mode at a time you set, and tuned to a channel or input of your preference. Before setting this function, make sure you set the correct current time.

Clock Set: Sets the current time and date.

Auto/Manual (except Australia and New Zealand)

Select [Manual] to set current time manually.

Automatic time zone

Sets whether or not to automatically select the time zone you are in.

On: Automatically switches between summer time and winter time according to the calendar.

Off: The time is displayed according to the time difference set by [Time Offset].

Automatic daylight saving time

Sets whether or not to automatically switch between summer time and winter time.

Date

Set current date.

Time

Set Current Time.

Time Offset

Allows you to manually select the time zone you are in, if it is not the same as the default time zone setting for your country/region.

Recording device setup (Australia and New Zealand model only)

To register and deregister HDD for recording function.

Recording Time Auto Update:

On

Recording time will be updated automatically based on changes in the broadcast signal.

Off

Recording time will be based on time of the booking/reservation.

It is recommended not to change this menu setting when you have existing booked timers.

Auto Start-up

Starts the initial set-up procedure. This option allows you to retune the TV after moving houses, or to search for new channels that have been launched by broadcasters.

Language

Select the language in which the menus are displayed.

Physical keyboard (for web browser* only)

Select the physical keyboard language when physical keyboard is connected to the TV.

* Only on limited region/country/TV model.

Start-up Logo

Select [On] to display the logo when the TV is turned on. Select [Off] to disable it.

LED Indicator

Select [On] to light up the LED indicator. Select [Off] to disable it.

AV Set-up

Video Labels: Assigns name to external equipment input.

Enable: Select [Auto] to display names only when the equipment is connected, or [Always] to display regardless of connection status.

Label Inputs: Uses one of the preset labels to assign a name to connected equipment. Select [Edit] to create your own label.

Colour System: Selects the colour system according to the composite video signal from the input source.

Speakers: Select sound output from the TV speakers or external audio equipment.

Headphone/Audio Out: Sets the sound output to headphone, external audio systems or Active Subwoofer connected to the TV. Disconnect headphone from the TV when you select [Audio out (Fixed)], [Audio out (Variable)] or [Subwoofer].

Audio out (Fixed)

The audio output of the TV is fixed. Use your audio receiver's volume control to adjust the volume (and other audio settings) through your audio system.

Audio out (Variable)

When using an external audio system, volume output from audio out can be controlled using the TV's remote control.

Headphone Speaker Link: Switches the TV's internal speakers on/off when you connect headphone to the TV.

Headphone Volume: Adjusts the volume of the headphone.

Note

- This option is not available, when [Headphone/Audio Out] is set to [Audio out (Fixed)], [Audio out (Variable)] or [Subwoofer].

Subwoofer: To enable, set [Headphone/Audio Out] to [Subwoofer].

Subwoofer Level

Adjust subwoofer volume level.

Phase

Select the phase polarity.

Subwoofer Sync

Adjusts the time lag of Subwoofer sound.

Digital Audio Out: Sets the audio signal that is output by connecting using digital audio output (optical)* cable or HDMI cable.

* Only on limited region/country/TV model

Auto 1

Output compressed audio without change.

Auto 2

Output only compressed audio for multichannel content without change.

PCM

Always output in PCM.

TV Position: Improves the speaker settings when set as [Table-Top Stand] or [Wall Mount] according to your TV's position.

HDMI signal format (Only on limited region/country/TV model):

Standard format

Standard HDMI format for normal use.

Enhanced format

Set only when using devices supporting HDMI 2K HDR (High Dynamic Range) format.

Note

- HDMI IN 1 and HDMI IN 2 signal format changes at the same time.
- Change to [Standard format] if the picture and sound do not output correctly in [Enhanced format].
- Some contents may not be displayed as 2K HDR when 4K HDR contents playback from a source device.

BRAVIA Sync Settings

Allows the TV to communicate with equipment that is compatible with the BRAVIA Sync Control function, and connected to the HDMI ports of the TV. Note that communication settings must also be made on the connected equipment.

BRAVIA Sync Control: Sets whether or not to link the operations of the TV and the connected equipment that is compatible with BRAVIA Sync Control. When set to [On], the following functions are available. If the specific Sony equipment that is compatible with BRAVIA Sync Control is connected, this setting is applied to the connected equipment automatically.

Auto Devices Off: When set to [On], the connected equipment that is compatible with BRAVIA Sync Control turns off when your TV goes to standby mode.

Auto TV On: When set to [On], the TV turns on when you turn on the connected equipment that is compatible with BRAVIA Sync Control.

BRAVIA Sync Device List: Displays a list of connected equipment that is compatible with BRAVIA Sync Control. Select [Enable] to update the [BRAVIA Sync Device List].

Device Control Keys: Select button functions of the TV's remote control to operate the connected equipment.

None

Deactivates the control by the TV's remote control.

Normal

For basic operations, such as navigation buttons (up, down, left or right, etc).

Tuning Keys

For basic operations and operation of channel-related buttons, such as **PROG +/-** or **(0-9)**, etc. Useful when you control a tuner or set-top box, etc; via the remote control.

Menu Keys

For basic operations and operation of the **HOME/OPTIONS** buttons. Useful when you select menus of a BD player, etc; via the remote control.

Tuning and Menu Keys

For basic operations and operation of channel-related buttons and **HOME/OPTIONS** button.

Note

- Some equipment with [BRAVIA Sync Control] does not support the [Device Control Keys] feature.

Customer Support

Provides information of your TV's model, software, and others. For details, see page 28.

Eco

Reset

Resets the current Eco settings to the default values.

Power Saving

Reduces power consumption of the TV by adjusting the backlight.

When you select [Picture Off], the picture is switched off. The sound remains unchanged.

Idle TV Standby

Turns the TV off after it has been kept idle for the preset length of time.

Customer Support

Model Name

Displays model name of your TV.

Software Version

Displays current software version of your TV.

Digital

Select [System Information] to display digital channel information of your TV.

External Inputs

View Video Labels: Allows you to view or manage the TV and external inputs.

Picture Check

View Test Picture: Allows you to check the picture condition on the display.

Software Update

Updates the TV system using USB memory or via Network.

Note

- Software update via the internet may vary depending on your region/country/TV model.
 - To update the software, please visit Sony support website.
-

Automatic Software Download

Select [On] to download the software automatically. Select [Off] to disable it.

Factory Settings

Resets all settings to factory settings. After completing this process, the initial set-up screen is displayed.

Note

- Be sure not to turn the TV off during this period (it takes about 30 seconds) or press any buttons.
-

Initialize Personal Information

You can erase your personal information stored in the TV.

Product Information

Displays your TV's product information.

Viewing Pictures from Connected Equipment

Connection Diagram

You can connect a wide range of optional equipment to your TV.

Note

- Depending on TV model, connecting a large USB device may interfere with other connected devices beside it.
- When connecting a large USB device, connect only 1 USB jack.

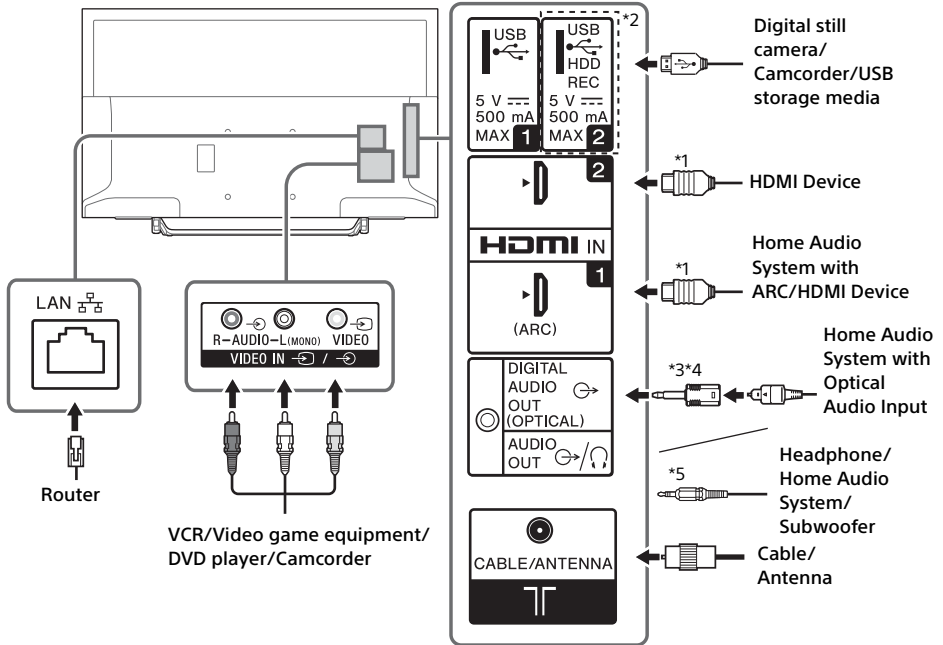

Note

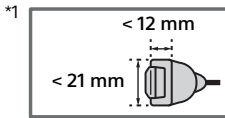

*2 Terminals and labels may vary depending on country/region/TV model.

*3 Only on limited region/country/TV model.

*4 Do not plug in the digital audio connector adapter when not connected to optical audio cable to disable red LED light from DIGITAL AUDIO OUT (OPTICAL) terminal.

Depending on the type of optical audio cable, the digital audio connector adapter may not be required.

*5 Supports 3-pole stereo mini jack only.

Picture Quality

- AV composite cable
- Antenna (aerial) cable

- HDMI cable







Standard definition (SD) videos have picture signals with a vertical resolution of 480 (NTSC) or 576 (PAL/SECAM) lines.



High definition (HD) videos have picture signals with a vertical resolution of 720 or 1,080 lines.

Using Audio and Video Equipment

- 1 Turn on the connected equipment.
- 2 Press  to display the input source.
- 3 Press / then  to select the desired input source.
The highlighted item is selected if 5 seconds pass without any operation.

Note

- When connecting a digital audio system not compatible with Audio Return Channel (ARC) technology using an HDMI cable, you need to connect an optical audio cable to the DIGITAL AUDIO OUT (OPTICAL)* to output digital sound.
- When connecting with an HDMI cable, be sure to use HighSpeed HDMI Cable with Cable Type Logo (Recommended SONY Cable).
- When connecting mono equipment, connect the audio cable to the L (mono) jack.

* Only on limited region/country/TV model.





To use BRAVIA Sync devices

When connecting the TV to BRAVIA Sync compatible equipment, you can control them together.

Be sure to perform the necessary settings in advance. The BRAVIA Sync Control settings must be set on both the TV and the connected equipment. See [BRAVIA Sync Settings] (page 27) for the settings on the TV side. Refer to the connected equipment operating instructions for the settings on the connected equipment side.

Using Screen mirroring

Screen mirroring displays the screen of a compatible device (e.g. smartphones) on your large TV screen by Miracast technology. No wireless router (or access point) is required to use this feature.

- 1 Press the / button, then select [Screen mirroring] using / buttons.
- 2 Operate the Screen mirroring compatible device to connect with the TV. Once connected, the device screen will be displayed on the TV.

To show connected devices/deregister device

When the waiting screen for the Screen mirroring is displayed, press **OPTIONS**, then select [Show Device List / Delete].

To deregister a device, select the device in the list to delete, press . Then, select [Yes] in the confirmation display.

To display registration notification when attempting to connect a device with the TV

Activating this function can avoid an unintended device from being connected.

When the standby screen for Screen mirroring is displayed, press **OPTIONS**, then select [Registration Notification] → [On].

Note that once you decline registration request from a device, you will not be able to connect the device unless you delete it from the device list.

To change the band setting (for experts)

When the standby screen for Screen mirroring is displayed, press **OPTIONS**, then select [Band Setting].

Note

- Connecting devices must conform to the following:
 - Screen mirroring compatible devices:
 - 2.4 GHz connection (5 GHz not supported).
- For information about the supported wireless band of your device, refer to the instruction manual of your device.

Additional Information

Installing the TV to the Wall

This TV's instruction manual only shows the steps on preparing the installation of the TV before installing to the wall.

To Customers:

For product protection and safety reasons, Sony strongly recommends that installation of your TV be performed by Sony dealers or licensed contractors. Do not attempt to install it yourself.

To Sony Dealers and Contractors:

Provide full attention to safety during the installation, periodic maintenance and examination of this product.

Sufficient expertise is required for installing this product, especially to determine the strength of the wall for withstanding the TV's weight. Be sure to entrust the attachment of this product to the wall to Sony dealers or licensed contractors and pay adequate attention to safety during the installation. Sony is not liable for any damage or injury caused by mishandling or improper installation.

Use the Wall-Mount Bracket SU-WL450 (not supplied) to install the TV to the wall.

When installing the Wall-Mount Bracket, also refer to the Operating Instructions and Installation Guide supplied with the Wall-Mount Bracket.

Note

- If the Table-Top Stand is attached to the TV, detach the Table-Top Stand beforehand. See the Setup Guide and follow in reverse order the steps to detach the Table-Top Stand.
- Place the TV with its screen facing down on a level and stable surface covered with a thick and soft cloth, when securing the Mounting Hook or when removing the Table-Top Stand from the TV to prevent damaging the surface of the LCD display.

To detach the Table-Top Stand from the TV

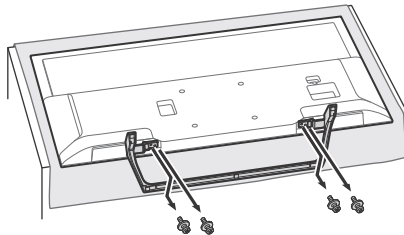

- 1 Make sure that the wall has enough space for the TV and is capable of supporting a weight of at least four times that of the TV. Refer to the following table on installing the TV to the wall. See page 39-40 (Specifications) for the TV's weight.

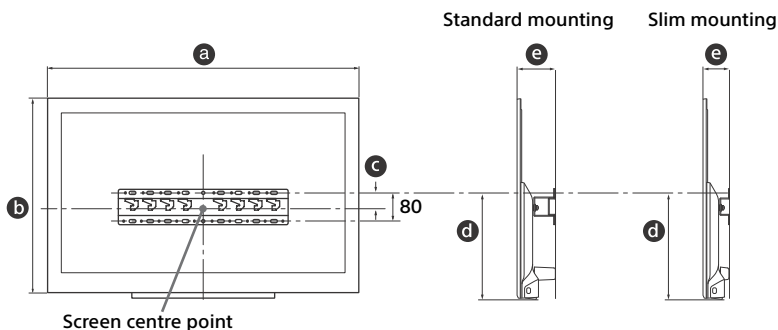

Unit: mm

Model Name KDL-	Display dimensions		Screen centre dimension	Length for mounting		
	a	b	c	d	Standard mounting	Slim mounting
49W750E	1,096	644	16	316	113	71
49W660E	1,102	650	16	319	113	71
43W750E	964	571	22	322	113	71
40W660E	910	543	39	325	113	71
32W660E 32W610E	731	442	85	316	113	71

Note

- Figures in the table may differ slightly depending on the installation.
- When your TV is installed on the wall, the upper side of the TV slightly leans forward.

- 2 Attach the Attachment parts for Wall-Mount Bracket. Check the Attachment parts by referring to "1" of the Wall-Mount Bracket Installation Guide.

Note

- If using an electric screwdriver, set the torque at approximately 1.5 N·m (15 kgf·cm).
- Be sure to store the unused parts in a safe place for future use. Retain this manual for future reference.

Standard mounting

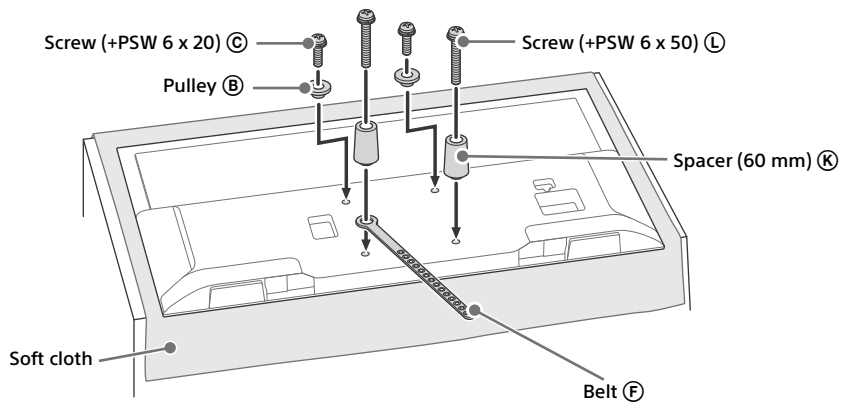

Slim mounting

Note

- You cannot use some of the terminals on the rear of the TV when using this mounting style.

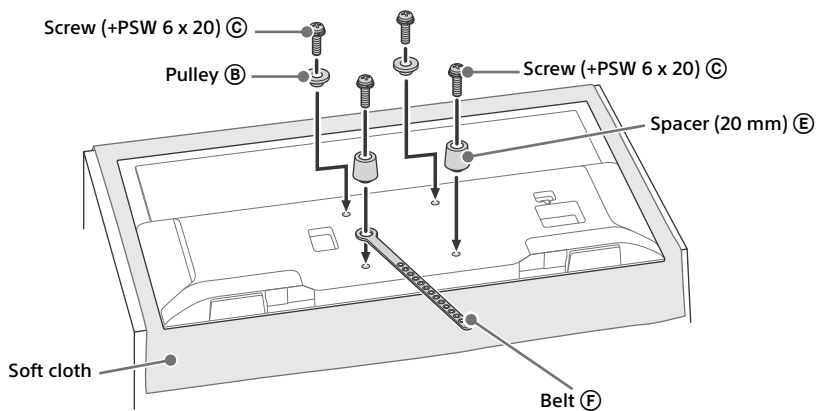
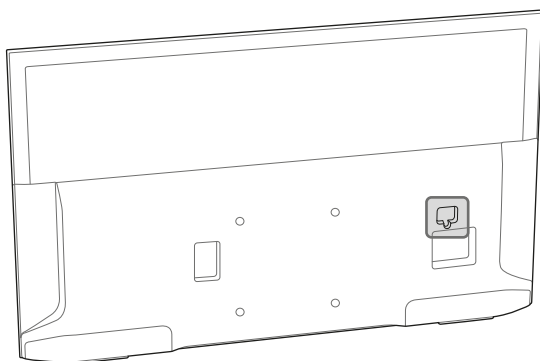

3 Connect necessary cables to the TV.

Note

- You cannot access to any terminal after installing the TV to the wall.

4 Install the TV to the Base. Refer to “5” of Installation Guide and “Installing the TV to the Wall” of Operating Instructions supplied with the Wall-Mount Bracket.

Model Name KDL-	Hook location
49W750E 49W660E	c
43W750E 40W660E 32W660E 32W610E	d

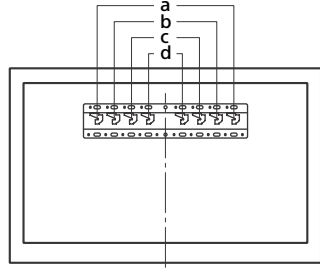

Refer to the instructions supplied with the Wall-Mount Bracket for your model to install the TV on the wall.

Troubleshooting

When the LED indicator is flashing red, count how many times it flashes (interval time is three seconds).

If the LED indicator flashes red, reset the TV by disconnecting the AC power cord (mains lead) from the TV for two minutes, then turn on the TV.

If the problem persists, contact your dealer or Sony service centre with the number of times the LED indicator flashes red (interval time is three seconds). Press \odot on the TV to turn it off, disconnect the AC power cord (mains lead), and inform your dealer or Sony service centre.

When the LED indicator is not flashing, check the items as follows.

If the problem persists, have your TV serviced by qualified service personnel.

Picture

No picture (screen is dark) and no sound

- Check the antenna (aerial)/cable connection.
- Connect the TV to the AC power outlet (mains socket), and press \odot on the TV or the remote control.

No picture or no menu information from equipment connected to the video input jack appears on the screen

- Press \rightarrow to display the connected equipment list, then select the desired input.
- Check the connection between the optional equipment and the TV.

Double images or ghosting

- Check the antenna (aerial)/cable connection, location or direction.

Only snow and noise appear on the screen

- Check if the antenna is broken or bent.
- Check if the antenna has reached the end of its serviceable life (three to five years in normal use, one to two years at the seaside).

Distorted picture (dotted lines or stripes)

- Keep the TV away from electrical noise sources such as cars, motorcycles, hair-dryers or optional equipment.
- When installing optional equipment, leave some space between the optional equipment and the TV.
- Check the antenna (aerial)/cable connection.

- Keep the antenna cable away from other connecting cables.

Picture or sound noise when viewing a TV channel

- Adjust [AFT] (Automatic Fine Tuning) to obtain better picture reception. This function is for analogue TV channels only.

Tiny black points and/or bright points appear on the screen

- The picture of a display unit is composed of pixels. Tiny black points and/or bright points (pixels) on the screen do not indicate a malfunction.

Picture contours are distorted

- Change the current setting of [Film mode] to other settings (page 19).

No colour on programmes

- Select [Reset] (page 18).

No picture from the connected equipment appears on the screen

- Turn the connected equipment on.
- Check the cable connection.
- Press \rightarrow to display the connected equipment list, then select the desired input.
- Correctly insert the memory card or other storage device in the digital still camera.
- Use a digital still camera memory card or other storage device that has been formatted according to the instruction manual supplied with the digital still camera.
- Operations are not guaranteed for all USB devices. Also, operations differ depending on the features of the USB device and the video being played.

Cannot select the connected equipment on the menu or cannot switch the input

- Check the cable connection.

Sound

No sound, but good picture

- Press \triangleleft +/- or \times (Mute).
- Check if [Speakers] in [AV Set-up] is set to [TV Speakers] (page 26).
- Check if the headphone plug is connected to the TV.

No sound or noisy sound

- Check if the TV system setting is appropriate (page 19).

Channels

The desired channel cannot be selected

- Switch between digital and analogue mode and select the desired digital/analogue channel.

Some channels are blank

- The channel is for scrambled/subscription service only. Subscribe to a pay TV service.
- Channel is used only for data (no picture or sound).
- Contact the broadcaster for transmission details.

Digital channels are not displayed

- Contact a local installer to find out if digital transmissions are provided in your area.
- Upgrade to a higher gain aerial.

Network

What kind of devices can be connected to use the Screen mirroring function?

- Sony Screen mirroring compatible devices (Xperia) can be connected.

Video or sound sometimes cuts out

- Devices emitting radio waves, such as other wireless LAN devices or microwave ovens, may interfere with the Screen mirroring function using wireless LAN. Keep the TV or Sony Screen mirroring compatible devices (Xperia) away from such devices, or turn them off if possible.
- Communication speed may change according to the distance or obstacles between devices, device configuration, radio wave condition, line congestion or what device you use. Communication may cut out due to the radio wave condition.

Some pay contents cannot be played

- The source device needs to be compatible with HDCP (High-bandwidth Digital Content Protection) 2.0/2.1 system. Some pay contents may not be displayed via a non-compatible source device.

Apps are inaccessible

- Check that the LAN cable or AC power cord of the router/modem* has been connected properly.
- * Your router/modem must be set in advance to connect to the Internet. Contact your Internet service provider for router/modem settings.
- Try using apps later. The app content provider's server may be out of service.

Sometimes video streaming quality is poor when using the wireless LAN

- The wireless network connection quality varies depending on the distance or obstacles (e.g. wall) between the TV and the wireless router (access point), environment interference, and quality of the wireless router (access point).

Wireless LAN connection fails or radio reception conditions are poor

- Check the installation location of the TV and wireless router (access point). Signal condition may be affected for the following reasons.
 - Other wireless devices, microwaves, fluorescent lights, etc., are placed nearby.
 - There are floors or walls between the wireless router (access point) and TV.
 - If the problem persists even after checking the above, try making a wired LAN connection.

Poor picture on Internet Video

- Quality depends on the original video provided by the internet contents provider and your connection bandwidth.

Certain internet contents displays a loss of detail, especially during fast-motion or dark scenes

- Video quality and picture size depend on broadband speed and delivery by content providers.

Good picture quality but no sound on the internet contents

- Quality depends on the original content provided by the internet contents provider and your connection bandwidth.
- Due to the nature of Internet video, not all videos will contain sound.

Your TV cannot connect to the server

- Check the LAN cable or connection to your server and your TV.
- Check if your network is properly configured on your TV.

A message appears stating that the TV cannot connect to your network

- Check the current network settings. Press **HOME**, then select [Settings] → [System Settings] → [Set-up] → [Network] → [Network Set-up] → [View Network setting and status]. If all of your network settings are "-", your server may not be connected properly. Check your network connections and/or server's instruction manual for connection information.

- Reconfigure your network settings.
- If the LAN cable is connected to an active server and the TV has acquired an IP address, check your DLNA Certified™ media server's connections and configurations.

Note

- Your IP address configuration can be viewed by selecting the [View Network setting and status] option.

DLNA Certified™ media server is inaccessible although it is listed under [Media] in the Home Menu

- Check your LAN cable/connection or your server connections. The TV may have lost connection with the server.
- Perform [Server Diagnostics] to check if your media server is properly communicating with the TV. Press **HOME**, then select [Settings] → [System Settings] → [Set-up] → [Network] → [Home Network Setup] → [Server Diagnostics].

When using the renderer function, music files cannot be played back

- Some applications display a photo file pre-installed in the PC simultaneously with music playback when using the renderer function. Depending on the pre-installed photo file, music playback may not be possible, but may become possible by changing the photo file.

You could not connect Internet

- Check that the LAN cable or AC power cord of the router/modem* has been connected properly.
- * Your router/modem must be set in advance to connect to the Internet. Contact your Internet service provider for router/modem settings.

You do not have YouTube ID

- If you do not have a YouTube ID and password, register them through the address below.
<http://www.google.com/device>
 (You can also register a YouTube ID and password from your PC.)
 After registering your ID, you can use it immediately.

General

The TV turns off automatically (the TV enters standby mode)

- Check if the [Sleep Timer] is activated (page 25).
- Check if the [Duration] is activated by [On Timer] (page 24) or [Photo Frame Settings] (page 24).
- Check if the [Idle TV Standby] is activated (page 27).

Some input sources cannot be selected

- Select [Video Labels] and select [Always] of the input source (page 26).

The remote control does not function

- Replace the batteries.

HDMI equipment does not appear on [BRAVIA Sync Device List]

- Check that your equipment is compatible with BRAVIA Sync Control.

Cannot select [Off] in [BRAVIA Sync Control]

- If you have connected any audio system that is compatible with BRAVIA Sync Control, you cannot select [Off] in this menu. To change the audio output to the TV speaker, select [TV Speakers] in the [Speakers] menu (page 26).

The [Parental Lock] password has been forgotten

- Enter 9999 for the PIN code.
- Update PIN code by pressing **HOME** and select [Settings] → [System Settings] → [Parental Lock] → [Change PIN Code].

Store Display Mode or Promoting Feature Logo appears on the screen

- On the remote control, press  **RETURN** then press **HOME** and select [Settings] → [System Settings] → [Set-up] → [Auto Start-up]. Be sure to select [Home] in [Location].

Specifications

System

Panel system

LCD (Liquid Crystal Display) Panel, LED backlight

TV system

Depend on your country/area selection

Analogue: B/G, I, D/K, M

Digital: DVB-T/DVB-T2

Colour/video system

Analogue: PAL, SECAM, NTSC3.58, NTSC4.43

Digital: MPEG-2 MP@ML/HL, H.264/MPEG-4 AVC MP/HP@L4, H.265/HEVC MP/Main10@L4.1 (Full HD 60fps)

Channel coverage

Depend on your country/area selection

Analogue: UHF/VHF/Cable

Digital: UHF/VHF

Sound output (Only for 19.5 V supply)

5 W + 5 W

Wireless technology

Protocol IEEE802.11b/g/n

Input/Output jacks

Antenna (aerial)/cable

75 ohm external terminal for VHF/UHF

VIDEO IN

Video input (phono jack)

AUDIO IN

Audio input (phono jacks)

HDMI IN 1 (ARC), HDMI IN 2 (HDCP 1.4-compatible)

HDMI Video: 1080p(30, 50, 60 Hz), 1080/24p, 1080i(50, 60 Hz), 720p(30, 50, 60 Hz), 720/24p, 576p, 576i, 480p, 480i

PC input: (Horizontal × Vertical, Horizontal frequency, Vertical frequency)

KDL-49W750E / 49W660E / 43W750E /

40W660E / 32W660E:

640 × 480, 31.5 kHz, 60 Hz

800 × 600, 37.9 kHz, 60 Hz

1,024 × 768, 48.4 kHz, 60 Hz

*1,280 × 720, 44.8 kHz, 60 Hz

1,280 × 1,024, 64.0 kHz, 60 Hz

1,152 × 864, 67.5 kHz, 75 Hz

1,600 × 900, 55.9 kHz, 60 Hz

1,680 × 1,050, 65.3 kHz, 60 Hz

*1,920 × 1,080, 67.5 kHz, 60 Hz

KDL-32W610E:

640 × 480, 31.5 kHz, 60 Hz

800 × 600, 37.9 kHz, 60 Hz

1,024 × 768, 48.4 kHz, 60 Hz

*1,280 × 720, 44.8 kHz, 60 Hz

1,360 × 768, 47.7 kHz, 60 Hz

1,152 × 864, 67.5 kHz, 75 Hz

1,600 × 900, 55.9 kHz, 60 Hz

1,680 × 1,050, 65.3 kHz, 60 Hz

* The 1080p and 720p timing when applied to the HDMI input will be treated as a video timing and not PC timing for Wide mode.

Audio: Two channel linear PCM: 32, 44.1 and 48 kHz, 16, 20 and 24 bits, Dolby Digital, Dolby Digital Plus, DTS

ARC (Audio Return Channel) (HDMI IN 1 only)
(Two channel linear PCM: 48 kHz, 16 bits, Dolby Digital, Dolby Digital Plus, DTS)

⇨ DIGITAL AUDIO OUT (OPTICAL)

Digital optical jack (Two channel linear PCM: 48 kHz, 16 bits, Dolby Digital, DTS)

⇨ AUDIO OUT/⇨ (Stereo mini jack)

Headphone, Audio output, Subwoofer

•⇨-1, •⇨-2 (except Australia and New Zealand model)

USB port

•⇨-1, •⇨-2 (HDD REC) (Australia and New Zealand model only)

USB port

DC IN 19.5 V ⇨⇨⇨

AC adapter input

LAN

10BASE-T/100BASE-TX connector (Depending on the operating environment of the network, connection speed may differ. 10BASE-T/100BASE-TX communication rate and communication quality are not guaranteed for this TV.)

Others

Optional accessories

Wall-Mount Bracket: SU-WL450

Operating temperature

0 °C – 40 °C

Power and others

Power requirements

19.5 V DC with AC adapter

Rating: Input 100 V - 240 V AC, 50/60 Hz

Energy Efficiency Class^{*1}

KDL-49W660E: A+

KDL-40W660E: A+

Screen size (measured diagonally) (approx.)

KDL-49W750E / 49W660E: 49 inches / 123.2 cm
KDL-43W750E: 43 inches / 108.0 cm
KDL-40W660E: 40 inches / 101.4 cm
KDL-32W660E: 32 inches / 80.1 cm
KDL-32W610E: 32 inches / 80.0 cm

Power consumption

Indicated on the rear of the TV

Power consumption*1

In [Standard] mode
KDL-49W660E: 60 W
KDL-40W660E: 48 W
In [Vivid] mode
KDL-49W660E: 85 W
KDL-40W660E: 60 W

Average annual energy consumption*1+2

KDL-49W660E: 88 kWh
KDL-40W660E: 70 kWh

Standby power consumption*1+3+4

KDL-49W660E: 0.50 W
KDL-40W660E: 0.50 W

Display resolution

KDL-49W750E / 49W660E / 43W750E / 40W660E / 32W660E: 1,920 dots (horizontal) × 1,080 lines (vertical)
KDL-32W610E: 1,366 dots (horizontal) × 768 lines (vertical)

Dimensions (Approx.) (w × h × d)

with Table-Top Stand

KDL-49W750E: 1,096 × 694 × 252 mm
KDL-49W660E: 1,102 × 699 × 230 mm
KDL-43W750E: 964 × 619 × 236 mm
KDL-40W660E: 910 × 591 × 208 mm
KDL-32W660E / 32W610E: 731 × 490 × 187 mm

without Table-Top Stand

KDL-49W750E: 1,096 × 644 × 70 mm
KDL-49W660E: 1,102 × 650 × 70 mm
KDL-43W750E: 964 × 571 × 70 mm
KDL-40W660E: 910 × 543 × 70 mm
KDL-32W660E / 32W610E: 731 × 442 × 70 mm

Mass (Approx.)

with Table-Top Stand

KDL-49W750E: 12.1 kg
KDL-49W660E: 12.1 kg
KDL-43W750E: 9.7 kg
KDL-40W660E: 8.7 kg
KDL-32W660E / 32W610E: 6.2 kg

without Table-Top Stand

KDL-49W750E: 11.5 kg
KDL-49W660E: 11.4 kg
KDL-43W750E: 9.1 kg
KDL-40W660E: 8.1 kg
KDL-32W660E / 32W610E: 5.8 kg

*1 This information is for EU and other countries whose relevant regulation is based on EU energy labelling regulation.

*2 Energy consumption per year, based on the power consumption of the television operating 4 hours per day for 365 days. The actual energy consumption will depend on how the television is used.

*3 Specified standby power is reached after the TV finishes necessary internal processes.

*4 Standby power consumption will increase when your TV is connected to the network.

Note

- Optional accessories availability depends on countries/region/TV model/stock.
- Design and specifications are subject to change without notice.

Notes on Digital TV function

- Any functions related to Digital TV (**DVB**) will only work in countries or areas where DVB-T/DVB-T2 (MPEG-2 and H.264/MPEG-4 AVC) digital terrestrial signals are broadcast. Please confirm with your local dealer if you can receive a DVB-T/DVB-T2 signal where you live.
- This TV set complies with DVB-T/DVB-T2 specifications, but compatibility with future DVB-T/DVB-T2 digital terrestrial broadcasts are not guaranteed.
- Some Digital TV functions may not be available in some countries/areas.

Notes on HDR (High Dynamic Range) (Only on limited region/country/TV model)

- Compatible only with HDR Game titles of all "PS4" via HDMI and HDR Videos of Built-in Netflix App. HDR image signal specifically means HDR10 Media Profile format (commonly referred to as HDR10).
- Not all HDR contents are guaranteed to be enjoyed on the TV.

Trademark information

- The terms HDMI and HDMI High-Definition Multimedia Interface, and the HDMI Logo are trademarks or registered trademarks of HDMI Licensing LLC in the United States and other countries.
- Manufactured under license from Dolby Laboratories.
Dolby, Dolby Audio, and the double-D symbol are trademarks of Dolby Laboratories.
- Opera® Devices SDK. Copyright 1995-2016 Opera TV AS. All rights reserved.
- Wi-Fi, Wi-Fi Direct, Miracast, Wi-Fi Protected Setup and Wi-Fi CERTIFIED Logo are trademarks or registered trademarks of Wi-Fi Alliance.
- “BRAVIA” and BRAVIA are trademarks of Sony Corporation.
- “Blu-ray Disc”, “Blu-ray” and “Blu-ray Disc” logo are trademarks of Blu-ray Disc Association.
- “PlayStation” is a registered trademark and “PS4” is a trademark of Sony Interactive Entertainment Inc.
- For DTS patents, see <http://patents.dts.com>. Manufactured under license from DTS, Inc.
DTS, the Symbol, & DTS and the Symbol together are registered trademarks, and DTS Digital Surround is a trademark of DTS, Inc. © DTS, Inc. All Rights Reserved.
- TUXERA is a registered trademark of Tuxera Inc. in the US and other countries.
- Windows Media is either a registered trademark or trademark of Microsoft Corporation in the United States and/or other countries.
- This product contains technology subject to certain intellectual property rights of Microsoft. Use or distribution of this technology outside of this product is prohibited without the appropriate license(s) from Microsoft.





Customer Support and Contact:

<http://www.sony-asia.com/support>

<http://www.sony.net/>

© 2017 Sony Corporation Printed in Malaysia